

**PANTOGRAFO**

- Pantografo monatesta con banco girevole e multivelocità.
- Particolarmente adatto per lavorazioni di leghe leggere, PVC, tubolare in acciaio e in inox.
- Capacità di lavoro 450x220x200 mm.

EQUIPAGGIAMENTO STANDARD:

- Nr. 2 morse pneumatiche
- Banco girevole 0-90°
- Gradi intermedi manuali
- Variatore di velocità da 0 a 12000 giri
- Motore trifase 2HP
- Nebulizzatore automatico
- Nr. 2 tastatori pneumatici (Tiger M)
- Pinza mandrino ER25 diam. 8 mm
- Nr. 1 utensile diam. 8 mm
- Nr. 2 dime standard (Tiger M)
- Battute per profilo
- Filtro aria
- Pistola aria
- Chiavi di servizio

ACCESSORI A RICHIESTA:

- Motore 3HP (differenza)
- Pinze di diverso diametro
- Dima vergine (Tiger M)
- Olio da taglio emulsionato confezione da 20 lt
- Imballo (gabbia in legno)
- Pinza ER32 per motore HP3

**FRAISEUSE A COPIER**

- Fraiseuse monotête avec table tournante et vitesse variable, particulièrement conçue pour alliages légers, PVC, tubulaires en acier inox et fer.
- Capacité de fraisage 450x220x200 mm

EQUIPMENT STANDARD:

- Nr. 2 étaux pneumatiques
- Table tournante 0-90°
- Degrés intermédiaires manuelles
- Variateur de vitesse de 0 à 12000 tpm
- Moteur triphasé 2HP
- Dispositif de pulvérisation
- Nr. 2 tâteurs pneumatiques (Tiger M)
- Pince mandrin ER25 diam. 8 mm
- Nr. 1 mèche diam. 8 mm
- Nr. 2 gabarits pour travail standard (Tiger M)
- Butées
- Unité de conditionnement de l'air
- Soufflette
- Clés de service

EQUIPMENT SUR DEMANDE:

- Moteur 3HP (différence de prix)
- Pinces de différent diamètre
- Gabarit vierge (Tiger M)
- Huile émulsionnée 20 lt
- Emballage (cage en bois)
- Pince ER32 pour moteur HP3

**FRESADORA COPIADORA**

- Fresadora copiadora de un cabezal con mesa de trabajo giratoria y velocidad variable.
- Maquina particularmente adecuada para el trabajo sobre aleaciones ligeras, PVC, tubular de acero inox y hierro.
- Capacidad de trabajo 450x220x200 mm.

EQUIPAMIENTO STANDARD:

- Nr. 2 mordazas neumaticas
- Mesa de trabajo giratoria 0-90°
- Grados intermedios manuales
- Variador de velocidad de 0 a 12000 rpm
- Motor trifasico 2HP
- Lubrificacion neumatica
- Nr. 2 palpadores neumaticos (Tiger M)
- Pinza ER25 diam. 8 mm
- Nr. 1 fresa diam. 8 mm
- Nr. 2 plantillas con ejecuciones standard (Tiger M)
- Topes
- Filtro de aire
- Pistola de aire
- Llaves de servicio

OPCIONALES:

- Motor 3HP (diferencia)
- Pinzas de diametro diferente
- Plantilla virgen (Tiger M)
- Aceite emulsionado 20 l
- Embalaje (jaula de madera)
- Pinza ER32 per motor HP3

**COPY ROUTER**

- Single head copy router with turning table and variable speed.
- Machine particularly indicated for working on light alloys, PVC and tubulars in steel and inox.
- Working capacity 450x220x200 mm.

STANDARD EQUIPMENT:

- Nr. 2 pneumatic clamps
- Turning table 0-90°
- Intermediate manual degrees
- Adjustable speed from 0 to 12000 rpm
- 2HP three phase motor
- pneumatic spray mist lubrication
- Nr. 2 pneumatic tracer points (Tiger M)
- Spindle collet ER25 diam. 8 mm
- Nr. 1 tool diam. 8 mm
- Nr. 2 standard copy templates (Tiger M)
- Profile stops
- Air filter
- Air gun
- Service spanners

OPTIONALS:

- 3HP motor (difference)
- Collets of different diameter (each)
- Virgin template (Tiger M)
- Emulsified cutting oil 20 l
- Packing (wooden crate)
- Spindle collet for 3HP motor

**KOPIERFRÄSMASCHINE**

- Einspindel Kopierfräsmaschine mit drehbarem Arbeitsplan und einstellbare Geschwindigkeit.
- Die Maschine ist besonders geeignet fuer Verarbeitungen auf leichten Legierungen, PVC, Inox und Stahl.
- Leistungsfähigkeit 450x220x200 mm.

NORMAL ZUBEHÖR:

- Nr. 2 pneumatische Spannungen
- Drehbare Arbeitsplan 0-90°
- Zwischen Graden Manuell
- Spindel drehzal von 0 bis 12000 U/Min.
- 2HP dreiphasig Motor
- Automatische Spruehgeraet
- Nr. 2 pneumatische Kopierstiften (Tiger M)
- Spindel mandrino ER25 diam. 8 mm
- Nr. 1 Fraesersatz d. 8 mm
- Nr. 2 Kopierschablonen (Tiger M)
- Profilschlaege
- Wartungseinheit
- Ausblaspistole
- Bedienungsschlüssel

SONDERZUBEHÖR:

- 3HP Motor (Differenz)
- Spannzangen mit verschiedenem Durchmesser
- Ungearbeitete Kopierschablone (Tiger M)
- Spruehmittelemlusion 20 lt
- Verpackung (Holzverschlag)
- Spindel ER32 für HP3 Motor

**FREZADORA COPIADORA**

- Pantógrafo de uma cabeça com banco giratório e multivelocidades.
- Particularmente adaptado para trabalhos em ligas leves, PVC, aluminio e inox.
- Capacidade de trabalho 450x220x200 mm

EQUIPAMENTO STANDARD:

- Nr. 2 apertos pneumaticos
- Banco giratório 0-90°
- Graus intermedios manual
- Variação da velocidade de 0 a 12000 rotações
- Motor trifasico 2HP
- Nebulizador automatico
- Nr. 2 apalpadores pneumaticos (Tiger M)
- Pinça mandril ER25 diam. 8 mm
- Nr 1 broca diam 8 mm
- Nr 2 placas standard (Tiger M)
- Batentes para perfil
- Filtro de ar
- Pistola de ar
- Chaves de manutenção

OPÇÕES:

- Motor 3HP (diferença)
- Pinças de diversos diâmetros
- Placa virgen (Tiger M)
- Olio de corte diluido em 20 litros
- Embalagem em caixa de madeira
- Pinça ER32 para motor HP3

LGF

Macchine per la lavorazione dell'alluminio e del pvc
Aluminium and pvc working machinery



 **TIGER - A**

 **TIGER - M**

PANTOGRAFO A CONTROLLO NUMERICO E MANUALE

COPY ROUTER CNC AND MANUAL

FRAISEUSE A COPIER A CONTROL NUMERIQUE ET MANUELLE

KOPIERFRÄSMASCHINE CNC UND MANUAL

FREZADORA COPIADORA A CONTROL NUMERICO Y MANUAL

FREZADORA COPIADORA A CONTROL NUMERICO E MANUAL

LGF

Via Togliatti, 81 - 47827 Villa Verucchio (RN) - Italy

Tel. 0541/677315 - Fax 0541/678752

www.lgf.it - info@lgf.it



TIGER A

TIGER M

Pannello di controllo
Control panel
Panneau de contrôle
Schalttafel
Panel de Control
Panel de Control



Variatore di velocità da 0 a 12000 giri
Adjustable speed from 0 to 12000 rpm
Variateur de vitesse de 0 à 12000 tpm
Spindel drehzal von 0 bis 12000 U/Min.
Variador de velocidad de 0 a 12000 rpm
Variação da velocidade de 0 a 12000 rotações

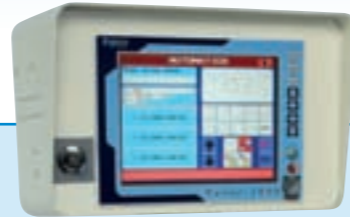

Macchina equipaggiata con unità CNC con touch screen a colori. Il controllo permette la realizzazione ed il salvataggio di lavorazioni sia nella memoria della macchine che con chiavetta USB. Il software facile ed intuitivo permette, attraverso l'uso di macro predefinite, una facile programmazione, assistita da una procedura "passo passo" che consente di dare una dimensione ed una posizione alla figura prescelta sul profilo da lavorare. E' inoltre possibile accodare programmi singoli salvandoli in un unico al fine di creare un ciclo di lavoro completo di tutte le lavorazioni necessarie su un determinato tipo di profilo.

Machine equipped with CNC control complete with colored touch screen. This control allows the creation of working projects to be saved either on the machine memory or directly on a flash drive through an USB port to be reloaded in the future. The machine's software, easy and intuitive allows, by means of pre-created macros, an easy programming of the project, assisted by a "step by step" procedure to give dimension as well as position on the profile of the chosen figure. Moreover it is possible to append singular programs into an entire new project creating a complete working cycle that includes all needed jobs to be executed into a profile.

Machine équipée d'un contrôle CNC écran tactile à couleurs. Le contrôle permet la réalisation et la sauvegarde d'usinages soit dans la mémoire des machines soit dans la clé USB. La simplicité du logiciel permet une programmation simple à travers l'utilisation de macros pré-définies. La programmation est aidée par une procédure "pas à pas" qui donne une dimension et une position à la forme choisie à usiner sur le profil. Il est possible également de mettre en file d'attente chaque programme en le sauvegardant dans un seul programme pour créer un cycle de travail complet de tous les usinages nécessaires sur un profil défini.







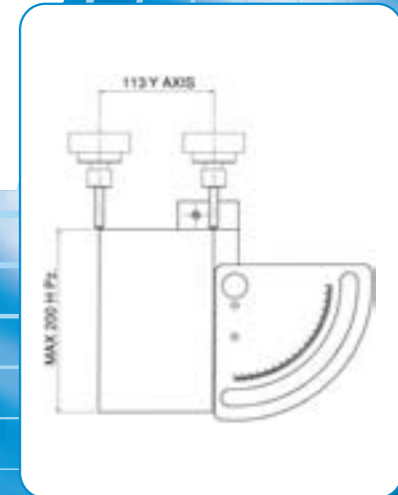
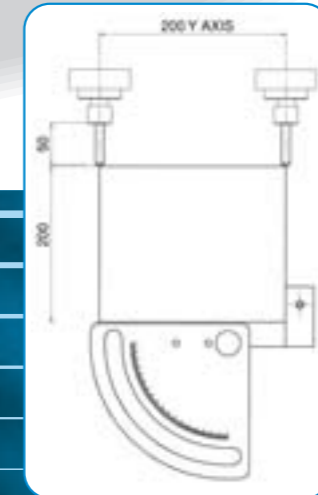

Máquina está equipada con unidad CNC con pantalla táctil a colores. El control permite realizar y guardar trabajos en la memoria de la máquina ó en un LÁPIZ-USB para poder recargar en el futuro. El software de la máquina, fácil e intuitivo permite, a través del uso de MACROS predefinidas, una fácil programación, asistida por un procedimiento "paso a paso", que consiste en dar una dimensión y una posición a la figura seleccionada sobre el perfil a trabajar. Además es posible añadir programas a un proyecto guardado, con el único fin de crear un ciclo de trabajo completo que incluya todos los trabajos necesarios a ejecutar en un tipo de perfil determinado.

Die Maschine ist mit einer CNC-Einheit mit Farb-Touchscreen ausgestattet. Die Steuerung erlaubt die Ausführung und Speicherung von Bearbeitungen sowohl im Speicher der Maschine als auch mit USB-Schlüssel. Die leichte und intuitive Software erleichtert die Programmierung durch Verwendung von vordefinierten Makrobefehlen, unterstützt von einer schrittweisen Prozedur, über die der ausgewählten Figur eine Dimension und eine Position auf dem zu bearbeitenden Profil gegeben werden kann. Darüber hinaus können einzelne Programme durch Speichern in einem einzigen Programm eingereicht werden, um einen vollständigen Arbeitszyklus zu schaffen, der alle notwendigen Bearbeitungen auf einem bestimmten Profiltyp vorsieht.

Máquina equipada de um Controlê CNC a Ecran Touchs Creen a Côres. O Controlê permite a realização e guardar as maquinações na memória do disco das máquinas ou na chave USB. A simplicidade do Software permite uma programação simples por macros pré definidos. A programação é ajudada passo a passo que dá uma dimensão e uma posição da forma escolhida para maquirar o perfil. Também é possível de pôr em fila de espera cada programa e de o guardar num só programa para crear um ciclo de trabalho completo de todas as maquinações necessárias num perfil defenido.

Banco girevole
Turning table
Table tournante
Drehbare Arbeitsplan
Banco giratório
Mesa de trabajo giratoria

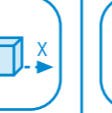

	 MOTOR MOTORE	 THREE-PHASE A TRE FASI	 MOTOR RPM RPM DEL MOTORE	 SPINDLE ATTACCO	 OPERATING PRESSURE PRESSIONE DI FUNZIONAMENTO	 AIR CONSUMPTION CONSUMO D'ARIA	 DIMENSIONS CM DIMENSIONI CM	 PACKAGING CM IMBALLAGGIO CM	 WEIGHT PESO
TIGER A	1,5 KW	400V - 50 Hz	12000 RPM	ER 25	7 bar	42 lt/ciclo	122x140x174	130x144x188	325
TIGER M	1,5 KW	400V - 50 Hz	12000 RPM	ER 25	7 bar	37 lt/ciclo	102x92x165	110x96x179	272

Le misure ed i pesi sono approssimativi. La Ditta si riserva di apportare le migliorie e modifiche senza alcun preavviso.
Les dimensions et les poids sont approximatifs. La maison peut apporter des améliorations et des modifications sans aucun préavis.
Weights and dimensions of machine, as well as performances, can be changed or modified at any time without notice.
Konstruktions- und Massänderungen bleiben vorbehalten.
A media e o peso são aproximados. A empresa pode modificar sem qualquer aviso.
Las medidas y pesos son aproximados. La empresa se reserva el derecho de modificarlas sin previso aviso.